

Effect of Hydrogen Enriched Hydrocarbon Combustion on Emissions and Performance

Jacob Wall

Department of Biological and Agricultural Engineering, University of Idaho

e-mail: wallja@vandals.uidaho.edu

The principle of this mode of combustion is to add a percentage of hydrogen gas to the combustion reactions of either compression or spark ignition engines. The addition of hydrogen has been shown to decrease the formation of NO_x , CO and unburned hydrocarbons. Studies have shown that adding hydrogen in percentages as low as 5-10% percent of the hydrocarbon fuel can reduce that hydrocarbon fuel consumption. The theory behind this concept is that the addition of hydrogen can extend the lean operation limit, improve the lean burn ability, and decrease burn duration.

To apply this method to an engine a source of hydrogen is needed. At this time the simplest option would be to carry a tank of hydrogen. Research is being conducted to allow the hydrogen to be reformed from the vehicles hydrocarbon fuel supply or produce hydrogen, on-board the vehicle from electrolysis of water. In the future, better methods could be developed for storing hydrogen in the vehicle or production of hydrogen on-board the vehicle.

1. Introduction

Combustion of fossil fuels has caused serious problems to the environment and the geopolitical climate of the world. The main negative effects on the environment by fossil fuel combustion are emissions of NO_x , CO, CO_2 , and unburned hydrocarbons. The main negative effect of burning fossil fuel on the geopolitical climate is the lack in supply of these fuels and the effect pollution has on politics.

There are several possible solutions to alleviate the problems of using fossil fuels, but most of them would require years of further development and additional infrastructure. This paper will look at a method of improving fossil fuel combustion that could be implemented without a large investment. This method involves burning hydrogen gas along with hydrocarbon fuels in engines.

2. Theory

In order to properly understand the effect of adding hydrogen to enrich hydrocarbon combustion it is important to understand the basics of how an internal combustion cycle works. Figure 1 shows a diagram of a four-stroke engine.

The four stroke engine cycle is made up of four phases: induction, compression, power, exhaust.

In the induction stroke the intake valve opens and the piston moves down pulling in air (diesel) or air/fuel (spark).

In the compression stroke both valves close and the piston moves up compressing the air mixture. Near the top of the stroke the spark plug fires or fuel is injected (diesel).

In the power stroke the fuel burns causing the pressure and temperature to rise driving the piston downward. This generates the rotation of the crankshaft. At the end of the power stroke the exhaust valve opens.

In the exhaust stroke the rotation of the crankshaft causes the piston to move up pushing the exhaust out the open exhaust valve. At the end of the exhaust stroke the exhaust valve closes. The cycle is then ready to repeat. [1]

In the experimentation and performance analysis of an engine several parameters are needed to quantify the results. Some of these parameters include air/fuel ratio, equivalence ratio, power, thermal efficiency, fuel consumption and emissions.

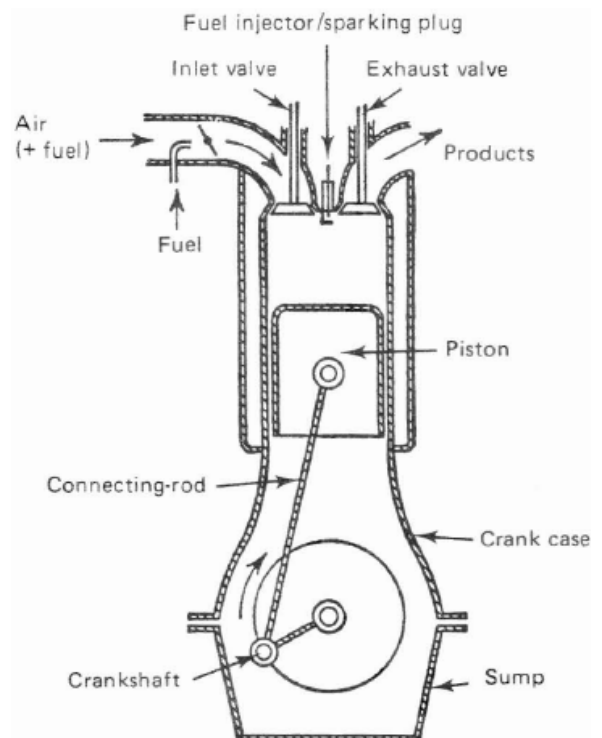

Fig. 1. Four Stroke Internal Combustion Engine [1]

The emissions of an engine are determined by its operating conditions. The main emissions of an engine are nitrogen oxidizes, carbon oxides, unburned hydrocarbons and water vapor.

NO_x . Nitrogen oxidizes are generally formed at high temperatures when N_2 is oxidized in air. This reaction is governed by the Zeldovich Mechanism, see Figure 2. Typically, if combustion temperature and residence time are minimized

and the appropriate amount of air is used NO emissions will be small. [2]

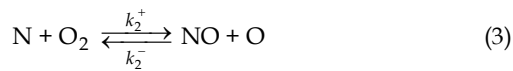
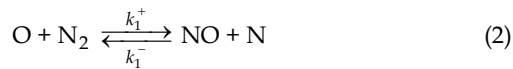

Fig. 2. Zeldovich Mechanism [2]

CO and CO₂. Carbon dioxide is the product of complete combustion. If sufficient oxygen is present then CO will be oxidized to CO₂. Carbon monoxide emissions are more likely to occur during rich mixture conditions. [2]

Unburned Hydrocarbon. Unburned hydrocarbons are created due to several conditions in the combustion process. In regions of the flame near the surfaces of the combustion chamber the heat lost through the chamber wall is greater than the heat needed to sustain a flame. This condition causes areas of quenched flame where hydrocarbons are left unburned.

The combustion chamber often has gaps and crevices that do not allow a flame to propagate. These areas allow for buildup of unburned Hydrocarbons.

During conditions where the engine is operating at part-load and reduced speed combustion is often incomplete. This is because the combustion velocity is too slow to allow the entire combustion charge to burn before it is expelled during the exhaust stroke. To prevent unburned hydrocarbon emissions, lean mixture conditions, high flame velocity and sufficient residence time at high temperature are beneficial. [2]

3. Hydrogen

Hydrogen holds significant promise as a supplemental fuel to improve the performance and emissions of spark ignited and compression ignited engines. Appendix A shows the properties of hydrogen in comparison to methane and gasoline.

Hydrogen has the ability to burn at extremely lean equivalence ratios. Hydrogen will burn at mixtures seven times leaner than gasoline and five times leaner than methane. [3] This lower limit is governed by the Le Chatelier Principle, which is the effect of thermodynamic and chemical properties on chemical equilibrium. [4]

The flame velocity of hydrogen is much faster than other fuels allowing oxidation with less heat transfer to the surroundings. This improves thermal efficiencies. Efficiencies are also improved because hydrogen has a very small gap quenching distance allowing fuel to burn more completely. The only drawback to hydrogen is that even though its lower heat value is greater than other hydrocarbon fuels it is less dense therefore a volume of hydrogen contains less energy. [3,5]

4. Application

The setup for introducing hydrogen into the engine involves a hydrogen source, tanks or on-board processor and metering equipment to measure various combustion parameters. This process can be applied to both spark ignited engines and compression engines.

Spark Ignition. Spark ignited engines can be either fueled by liquid fuels or gaseous fuels. Propane and methane are the gaseous fuels and gasoline and ethanol are the liquid fuels commonly used. It can be seen in Appendix A that gaseous fuels and liquid fuels have different properties and react differently to hydrogen addition, but both still benefit from hydrogen addition.

Various methods have been used to introduce hydrogen into the engine. In one study, hydrogen was mixed with air and compressed in a cylinder before introduction into the engine. [7] In studies using gaseous fuels hydrogen flow rate is matched with the primary fuel in-order to achieve the desired percentage of hydrogen enrichment. [8] The ultimate design for hydrogen introduction into an engine would be using a computer control system that would vary hydrogen percentage, equivalence ratio and throttle with the vehicles gas pedal for optimal running conditions. [9]

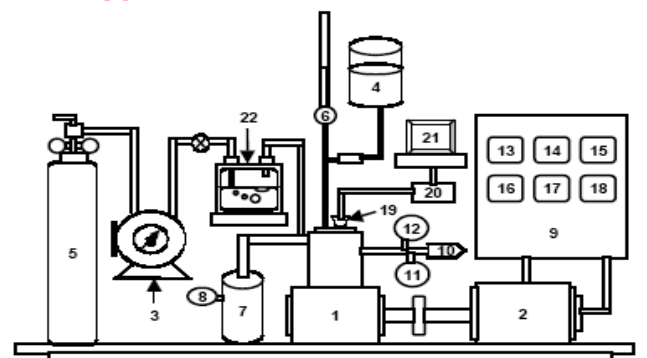

LEGEND

- | | | |
|----------------------|------------------------|--------------------------|
| 1.Engine | 9. Dynamometer panel | 17.Lub oil Temp. Indictr |
| 2.Dynamometer | 10. Silencer | 18. Rotameter |
| 3.Gas flow meter | 11. Smoke Pump | 19.Pressure Sensor |
| 4.Diesel Tank | 12. HC/CO Analyzer | 20. Charge Amplifier |
| 5.Hydrogen Cylinder | 13. Stop Watch | 21.DDA.System |
| 6.Burette (Diesel) | 14. RPM Indicator | 22. Flame Trap |
| 7. Air Tank | 15. Ext Temp Indicator | |
| 8. Air Flow meter | 16. Coolant Temp. Indr | |

Fig. 3. Sample Setup [6]

Compression Ignition. Compression Ignition engines can be fueled with standard diesel, biodiesel or straight vegetable oil. These engines have two options for introducing hydrogen into the combustion process. Hydrogen can be inducted with air into the intake manifold or it can be directly injected into the cylinder similar to the diesel fuel. [10]

5. Hydrogen Enriched Combustion

Thermal efficiency generally is increased with the introduction of hydrogen into an engine but it must be properly tuned in-order to gain these benefits. Results also seem to vary depending on the fuel used. A properly tuned compression engine will increase in thermal efficiency at high loads for hydrogen mass percent of about 8%. [6] For an engine to have optimal thermal efficiency the timing must be retarded to account for hydrogen's fast burn velocity. [11] Thermal efficiency is related to fuel consumption with the addition of hydrogen in all of the studies fuel consumption decreased. [6]

Figure 4 shows the effect of hydrogen addition on the efficiency of a compression ignition engine. This Figure shows the effect of hydrogen addition on thermal efficiency at two different load settings for diesel fuel and jatropa oil. In this

figure it can be seen that at 100% load, up to about 8% hydrogen addition increases engine thermal efficiency. At greater than 8% hydrogen addition thermal efficiency actually decreased. Hydrogen addition did not increase thermal efficiency at part load settings for this engine configuration. [6]

Figure 5 shows the effect of hydrogen addition on reduction in fuel consumption. This figure shows that with increased hydrogen addition fuel consumption decreases.

Hydrogen addition gives the engine the ability to be operated in the very lean mixture region. Lean mixtures allow for complete combustion decreasing carbon monoxide emissions [8].

Unburned hydrocarbon emissions are reduced because hydrogen allows lean mixtures. These emissions are also reduced because high flame velocity and small quenching distance of hydrogen promote complete combustion [12]. Figures 6 shows the effect that hydrogen addition has on engine CO emissions. In this figure it can be seen that over the range of engine loads increasing percentage of hydrogen addition decreases CO emissions. Figure 7 shows the effect of hydrogen addition hydrocarbon emissions. In this figure it can be seen that increases percentage of hydrogen addition decreases hydrocarbon emissions.

The addition of hydrogen increases combustion temperatures therefore creating conditions where it is easier for NOx to form if proper tuning is not utilized. Several studies have shown that if mixtures are made lean and spark timing is retarded NOx can be reduced to a point below normal hydrocarbon combustion. [2,10,11]

Figures 8 and 9 compare the effect on emissions of the addition of 70 grams per hour of hydrogen to an engine running at 3000 RPM. From these figures it can be seen that emissions of carbon monoxide, unburned hydrocarbons and nitrogen oxides are significantly reduced by the addition of hydrogen. These figures also show that hydrogen addition allows the engine to be operated in a more lean condition without negatively effecting emissions.

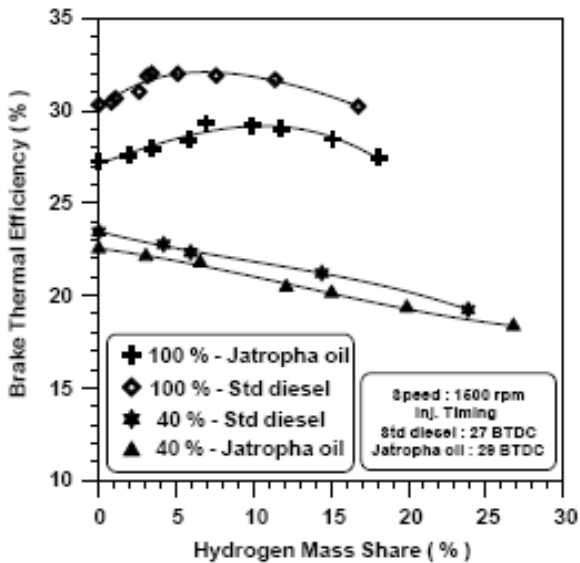

Fig. 4. Variation of thermal efficiency with hydrogen mass share [6]

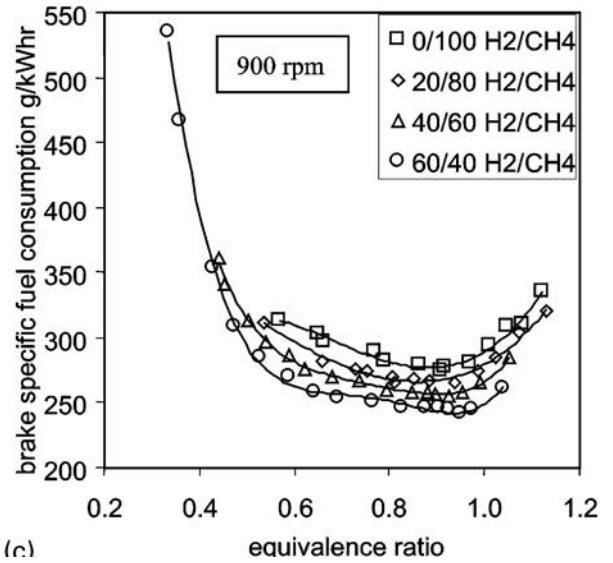

Fig. 5. Reduction in fuel consumption with increase in hydrogen addition [3]

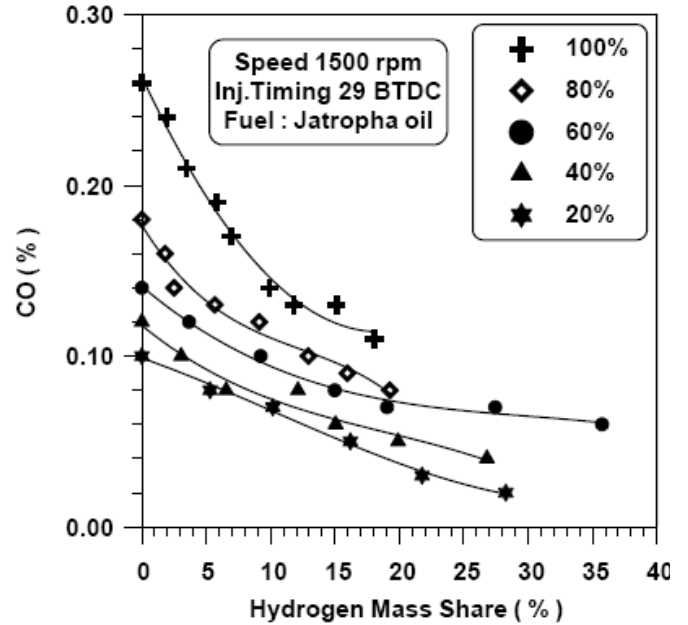

Fig. 6. Effect of H₂ addition on jatropha oil combustion CO emissions [6]

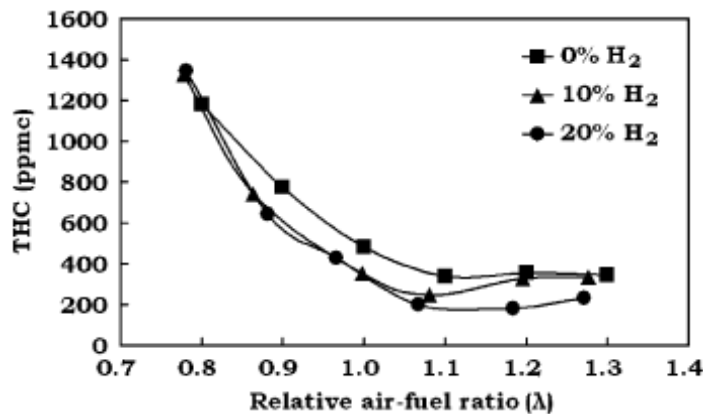

Fig. 7. Effect of H₂ addition on natural gas combustion hydrocarbon emissions [8]

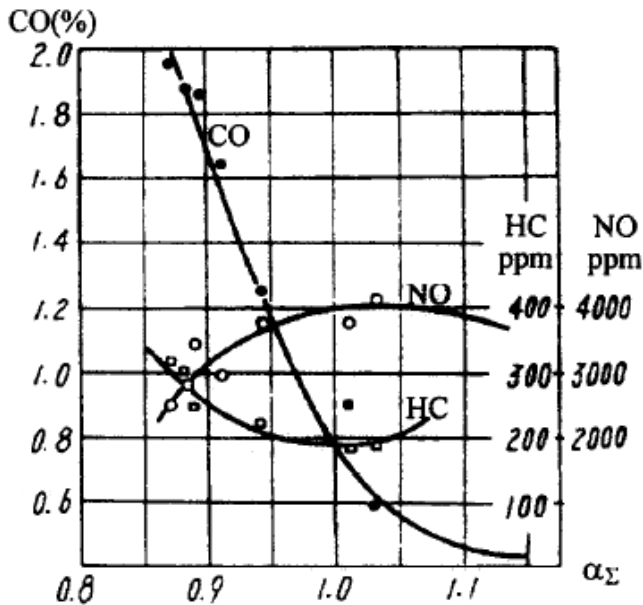

Fig. 2. Emission characteristics with gasoline fuel.

Fig. 8. Emission before hydrogen addition [2]

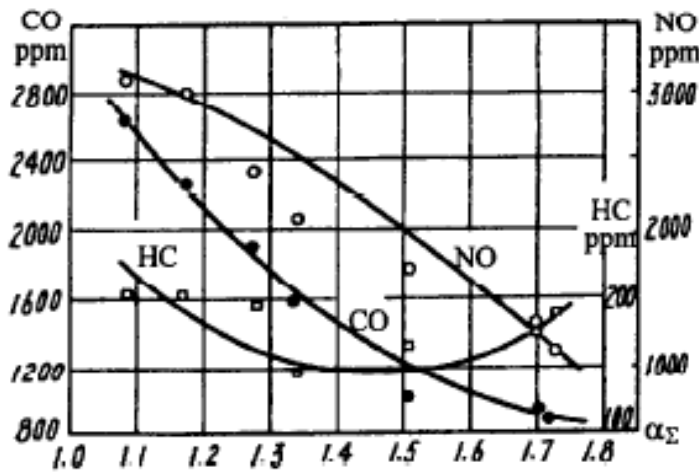

Fig. 9. Emission after hydrogen addition [2]

6. Hydrogen Production

The greatest limitations to using hydrogen for fuel enrichment are its cost and the difficulty of its production and storage. Currently, there are three main options for producing hydrogen for fuel enrichment. These options are:

1. Producing hydrogen from electrolysis or hydrocarbon reforming at a fixed location and compressing the hydrogen for storage on the vehicle in tanks.
2. Producing hydrogen, on-board by a hydrocarbon fuel reformer and introducing the hydrogen as needed from the vehicles hydrocarbon fuel supply.
3. Producing hydrogen, on-board, from water using electrolysis powered by the vehicles alternator.

Compressed Hydrogen. Compressed hydrogen is probably the simplest but most costly method for using hydrogen for fuel enrichment. The hydrogen must be generated off the vehicle, compressed and stored on the vehicle. All these steps require a great deal of cost.

Fuel Reformer. A fuel reformer uses plasmatrons, electrical gas heaters, which use the conductivity of gases at high temperature to convert the liquid fuel to a hydrogen-rich gas. Plasmatron fuel reformers have been shown to increase engine fuel efficiency by as much as 35% [13]. Figure 9 shows a sample diagram of a plasmatron fuel reformer. Table 1 shows the typical operating parameters of a low current plasmatron fuel reformer.

Power	50–300 W
Current	15–120 mA
H ₂ flow rate	30–50 l/min
Height	25 cm
Volume	2 l
Weight	3 kg

Table 1. Operating Parameters of a Low current plasmatron fuel reformer [14]

Water Electrolysis. Water electrolysis is the process of passing an electric current through water breaking the bonds of the water molecule to produce hydrogen and oxygen gases. Water electrolysis products have been shown to have a significant improvement on performance and emission when compared to adding hydrogen alone.

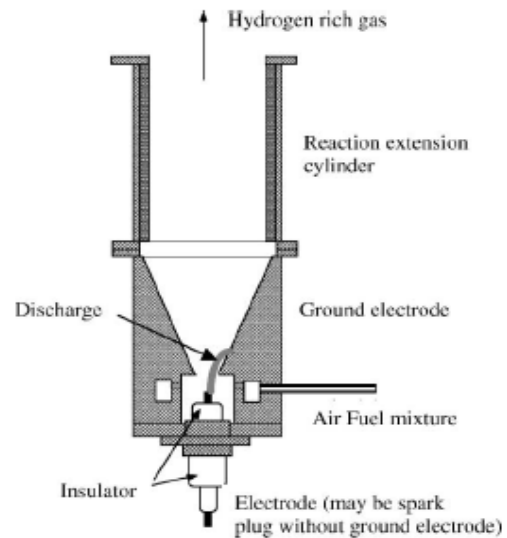

Fig. 10. Low current plasmatron fuel reformer [14]

The University of Windsor in Canada conducted a simulation of adding electrolysis products of 2 parts hydrogen to 1 part oxygen. This study used the CHEMKIN kinetic simulation software. It was found that adding 10% hydrogen and oxygen was equivalent to adding 20% hydrogen alone in reduction of emission and improvement of performance. [15]

In a second study, conducted by the University of Windsor an experimental method was developed to simulate the effects of adding electrolysis products to an engine. Due to the danger of compressing a mixture of hydrogen and oxygen, a tank with 98% air, 2% hydrogen and 1% oxygen was prepared. This mixture was then used to test the effect of electrolysis products. It was found that this mixture gave the same benefits of hydrogen alone and that the oxygen did not affect performance. [16]

Performance of a commercial electrolysis unit that produces 6.7 ml/s at 169 W was assumed as the baseline for on-board

hydrogen production. [7] It was assumed that electrolysis products contain only hydrogen and oxygen and no hydrogen or oxygen radicals. Also, no timing adjustments were made in this setup to optimize performance. This study concluded that an electrolysis unit would not provide enough performance increase to offset the energy required to run the electrolysis process. Figure 10 shows the University of Windsor estimation of the ability of an electrolysis unit to provide hydrogen to enrich combustion. [16]

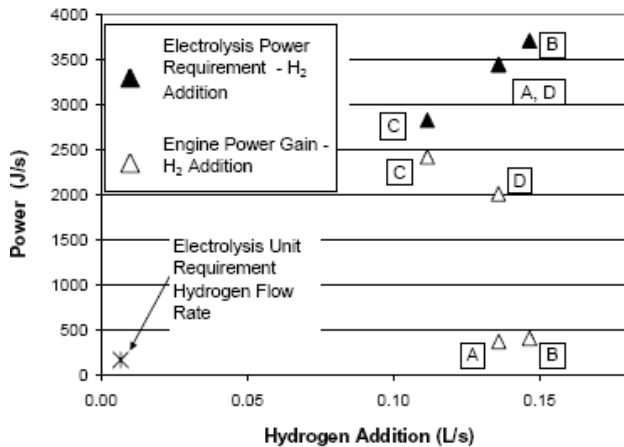

Fig. 11: The power requirement for electrolysis and the power gained from the engine through hydrogen addition (U of Windsor) [16]

In contrast to the findings of the University of Windsor study, Kocaeli University replicated a patent for an electrolysis system to provide hydrogen and oxygen for combustion enrichment. This unit is made of a cylindrical carbon cathode surrounding a platinum rod anode. This unit was supplied 90 volts at 3 A and produced about 20 L/h. [17] Figure 12 shows a diagram of Kocaeli University’s hydrogen enrichment setup. Table 2 shows the specifications of their electrolysis unit.

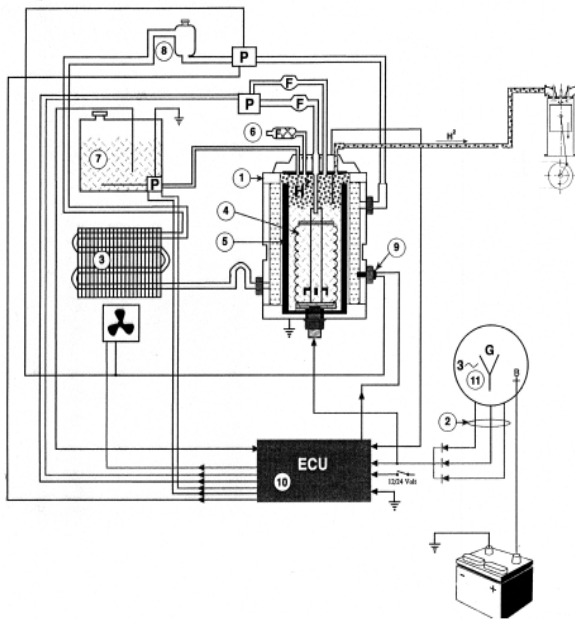

Fig. 1. General structure of the system (1. Electrolysis cell; 2. Secondary circuit; 3. Radiator; 4. Anode electrode; 5. Cathode electrode; 6. Air filter; 7. Water tank; 8. Cooling water tank; 9. Water temperature sensor; 10. Electronic control unit of the system; 11. Alternator. P — water pump, F — water filter).

Fig. 12. Electrolysis unit from Kocaeli University [17]

Maximum gas supply	20 l/h
Cathode electrode	Carbon
Anode electrode	Platinum
Electrolysis voltage	90 V
Electrolysis current	3 A
Water	Normal tap water
Water tank volume	2.5 l
Water consumption	100 ml/250 km
Water supply control	Electronically controlled
Water temperature range	45–50°C
Cooling	Water cooled
Dimensions	150 × 140 × 135 mm
Weight	2 kg

Table 2. Technical Specification for the Kocaeli Electrolysis Unit [17]

This system was tested on four vehicles. Changes in parameters of fuel consumption and emissions were measured. Table 3 displays the results for this test. It was shown that using this system to add electrolysis products to the engine increased fuel economy by 25–40%. The emissions, for these cars, were also tested and were reduced from between 40–50% depending on engine type. There was no noticeable reduction in the performance of these vehicles.

Kocaeli University Electrolysis test results	
Vehicle	% Increase Fuel Economy
1993 Volvo 940	42.9%
1996 Mercedes 280	36.4%
1992 Fiat Kartal	26.3%
1992 Fiat Dogan	33.3%

Table 3. Kocaeli University electrolysis test results [17]

From these two studies there appears to be a discrepancy between the theoretical modeled results and actual experiments conducted with electrolysis units in vehicles. Either the experiments were not conducted accurately or there is an error in the assumptions of the models for water electrolysis products effect on engines. Further testing should be conducted on actual electrolysis units in engines.

Although some of these sources are not highly scientific, there is a large amount of performance data on electrolytic gas production and its effects on engine performance, particularly improvement in fuel consumption from “backyard engineers”. Searches on YouTube and Yahoo Groups such as “Hydroxy” and “Watercar” reveal that many people have installed water electrolysis units, better known as “hydrogen boosters”, on their vehicles and are achieving fuel consumption improvements ranging from 25% to 40%. Several high performance units are even achieving results as high as 50% to 100%. There needs to be a complete investigation of these claims and this technology before discounting these results.

Brown’s Gas. During the 1970’s professor and inventor Yull Brown designed an electrolysis power torch for use in welding operations. This electrolysis unit was designed to pass the molecular hydrogen and oxygen output through an electric arc. Brown states in his patents that the electric arc splits the molecular hydrogen and oxygen into atomic hydrogen and oxygen radicals. When these atomic radicals are combusted there purportedly is an additional 218,000 cal per gram mole

released than is normally assumed to be released when molecular hydrogen and oxygen are combusted. [18]

FIG. 1.

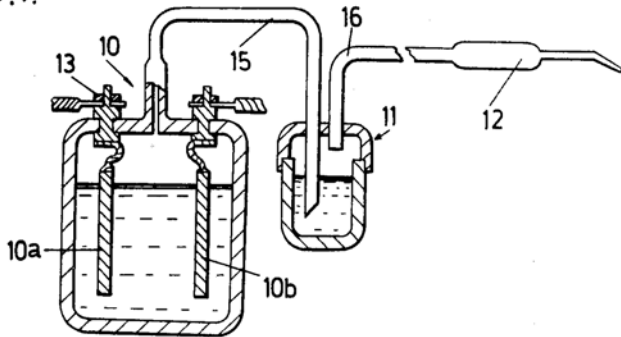

Fig. 13. Yull Brown's electrolysis unit from US Patent: 4,081,656 [18]

FIG. 5.

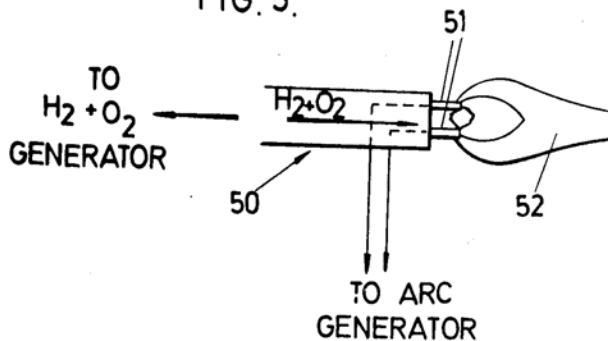

Fig. 14. Hydrogen passing through arc [18]

Electrolytic gas, often referred to as "Brown's Gas", has several interesting properties that have been observed and utilized. "Brown's Gas" can be generated without the need to separate the hydrogen and oxygen therefore, the electrical resistance between the anode and cathode can be minimized and electrolytic velocity can be maximized. Another interesting effect of combustion of the gas is that it burns implosively. This implosive burning is likely due to atomic hydrogen and oxygen being present. Studies suggest that implosion will only occur when there is less than 5% air in the mixture otherwise explosion occurs. [19]

When radical atoms of hydrogen and oxygen are bonded they form what is called crystallizing π -bonds. These π -bonds generate π -far infrared rays. These π -far infrared rays create a strong gravitational cavity that causes the substances to focus inward when burning. It has been observed that this effect produces a burning temperature of Brown's Gas in the range of more than 6000°C while normal hydrogen's burning temperature is in the range of 2700°C. [19]

Brown's Gas has been used for many unique processes. It can be used for welding metals and ceramics. Brown's gas incinerators are used to burn atomic waste and the radioactive rays are reduced to 1/3 - 1/20 of their original strength. [19]

In Korea, a Brown's Gas incinerator is used for vitrification of municipal solid waste. This unit uses 6 Brown's gas burners to melt heavy metal ash. This unit melts flying ash and glass cullet at a temperature of 1450°C. This unit was used to reduce the leachable concentration of heavy metals below the Korean regulatory limit. The electrolysis unit for this application is made

by the E&E Company and can produce 300 cubic meters per hour of Brown's Gas at 600 KWH.

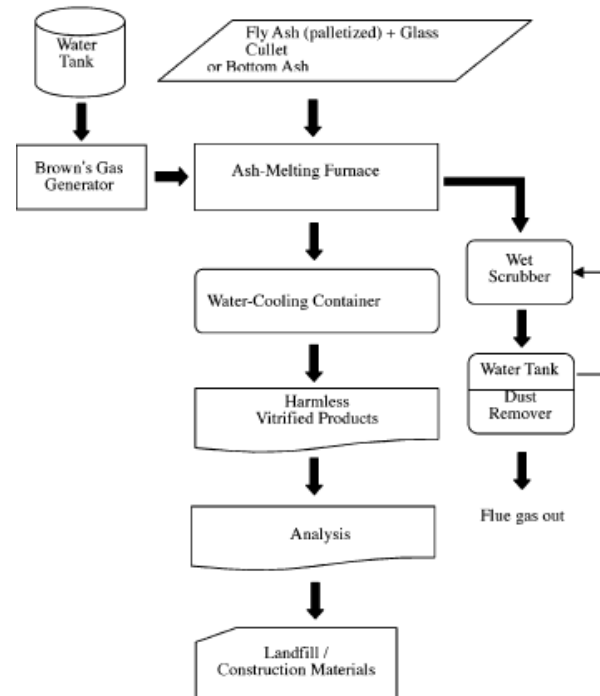

Fig. 15. Brown's Gas incinerator for vitrification of solid waste [20]

The unique properties of Brown's Gas clearly show that the gas cannot be assumed to only contain molecular hydrogen and oxygen. Brown's Gas experimentation has opened a very wide variety of applications for its use. Further research and experimentation must be conducted to determine if Brown's Gas can be produced on-board a vehicle to improve its efficiency and performance.

7. Conclusion

Introduction of hydrogen into the combustion process has been shown to:

1. Increase thermal efficiency and decrease fuel consumption.
2. Decrease carbon monoxide and unburned hydrocarbon emissions.
3. Increase NO_x emissions unless proper timing and mixture adjustments are used.
4. The challenge to using hydrogen as a supplemental fuel is the storage and generation of hydrogen.
5. Use of on-board electrolysis of water to create hydrogen to enrich combustion should be completely experimentally investigated before dismissing it as ineffective.

References

- [1] R. Stone, **Introduction to Internal Combustion Engines**, 3rd Ed., (SAE, Warrendale, Pa. 1999).
- [2] I. Jingding et al, "Formation and Restraint of Toxic Emissions in Hydrogen-Gasoline Mixture Fueled Engines", *Int J Hydrogen Energy* 23:971-975 (1998).
- [3] C. Bauer & T. Forest, "Effect of Hydrogen Addition on the Performance of Methane-Fueled Vehicles. Part I: Effect on S.I. Engine performance", *Int J Hydrogen Energy* 26:55-70 (2001).

- [4] L. Bortnikov, "Combustion of a Gasoline-Hydrogen-Air Mixture in a Reciprocating Internal Combustion Engine Cylinder and Determining the Optimum Gasoline-Hydrogen Ratio", *Combustion, Explosion, and Shock Waves* **43**:378-383 (2007).
- [5] J. Wang et al, "Combustion Behaviors of a Direct-Injection Engine Operating on Various Fractions of Natural Gas-Hydrogen Blends", *Int J Hydrogen Energy* **32**:3555-3564 (2007).
- [6] M. Kumar et al, "Use of Hydrogen to Enhance the Performance of a Vegetable Oil Fuelled Compression Ignition Engine", *Int J Hydrogen Energy* **28**:1143-1154 (2003).
- [7] T. Andrea et al, "The Addition of Hydrogen to a Gasoline-Fuelled SI Engine", *Int J Hydrogen Energy* **29**:1541-1552 (2004).
- [8] F. Ma et al, "Experimental Study on Thermal Efficiency and Emission Characteristics of a Lean Burn Hydrogen Enriched Natural Gas Engine", *Int J Hydrogen Energy*, doi: 10.1016/j.ijhydene.2007.07.048 (2007).
- [9] C. Bauer C & T. Forest, "Effect of Hydrogen Addition on the Performance of Methane-Fueled Vehicles. Part II: Driving Cycle Simulation", *Int J Hydrogen Energy* **26**: 71-90 (2001).
- [10] M. Masood et al, "Computational Combustion and Emission Analysis of Hydrogen-Diesel Blends with Experimental Verification", *Int J Hydrogen Energy* **32** :2539-2547 (2007).
- [11] N. Saravannan et al, "Experimental Investigation of Hydrogen Port Fuel Injection in DI Diesel Engine", *Int J Hydrogen Energy* (2007), doi:10.1016/j.ijhydene.2007.03.036
- [12] G. Choi et al, "Performance and Emissions Characteristics of a Hydrogen Enriched LPG Internal Combustion Engine at 1400 RPM", *Int J Hydrogen Energy* **30**:77-82 (2005).
- [13] L. Bromberg et al., "Compact Plasmatron-Boosted Hydrogen Generation Technology for Vehicular Applications", *Int J Hydrogen Energy* **24**:341-350 (1999).
- [14] L. Bromberg et al, "Emissions Reductions Using Hydrogen from Plasmatron Fuel Converters", *Int J Hydrogen Energy* **26**:1115-1121 (2001).
- [15] C. Uykur et al, "Effects of Addition of Electrolysis Products on Methane/Air Premixed Laminar Combustion", *Int J Hydrogen Energy* **26**:265-273 (2001).
- [16] T.D. Andrea et al, "Investigating Combustion Enhancement and Emissions Reduction with the Addition of 2H₂ + O₂ to a SI Engine", SAE Paper, 2003320011 (2003).
- [17] Z. Dulger & K. Ozcelik, "Fuel Economy Improvement by on Board Electrolytic Hydrogen Production", *Int J Hydrogen Energy* **25**:895-897 (2000).
- [18] Y. Brown, "Arc-assisted Oxy/hydrogen welding", U.S. Patent No. 4,081,656, (March 28, 1978).
- [19] O. Hung-Kuk, "Some comments on implosion and Brown gas", *J Materials Processing Tech* **95**:8-9(1999).
- [20] Park et al, "Vitrification of Municipal Solid Waste Incinerator Fly ash using Brown's Gas", *Energy & Fuels* **19**:258-262(2005).

Internet Resources on Water Electrolysis for Hydrogen Generation

- <http://www.panacea-bocaf.org/>
- <http://tech.groups.yahoo.com/group/Hydroxy/>
- <http://tech.groups.yahoo.com/group/watercar/>
- <http://tech.groups.yahoo.com/group/WaterFuel1978/?yguid=235652287>
- <http://tech.groups.yahoo.com/group/WorkingWatercar/?yguid=235652287>
- <http://www.hytechapps.com/>
- <http://www.smacksboosters.110mb.com/>
- <http://www.youtube.com/user/ZeroFossilFuel>
- <http://www.youtube.com/user/EletrikRide>
- <http://www.youtube.com/user/johnaarons>
- <http://www.waterfuelcell.org/>
- <http://www.alt-nrg.org/>
- <http://hydrogengarage.com/>
- <http://oupower.com/>
- <http://www.free-energy-info.com>
- <http://www.blogtalkradio.com/> search "water fuel"

Appendix

Listing of hydrogen properties along with methane, propane and gasoline for comparison

Properties	Hydrogen	Methane	Propane	Gasoline (iso-octane)
Chemical formula	H ₂	CH ₄	C ₃ H ₈	(C ₈ H ₁₈)
Minimum ignition energy (mJ) [1]	0.02	0.29	0.26	0.24
^a Flame speed (cm/s) [1]	237	42	46	41.5
^b Diffusion coefficient (cm ² /s) [1]	0.61	0.16	0.12	0.05
Quenching gap (cm) [1]	0.06	0.2	0.2	0.2
Higher heating value (MJ/kg) [2]	142	55	50.4	(47.3)
Lower heating value (MJ/kg) [2]	120	50.4	46.4	(44)
Molecular weight [1]	2.02	16.04	44.1	≈ 107 (114)
Lower heating value (kJ/mol) [3]	286	802	2043	(5100)

^aAt 20°C.

^bAt stoichiometric conditions.

Table 4. Comparison of Hydrogen, Gasoline and Methane [5]